

User manual

ONLINE XANTO series Models 6000 – 20000

Germany

ONLINE USV-Systeme AG
Luise-Ullrich-Str. 8
D-82031 Grünwald

Phone +49 (89) 2423990-10
Fax +49 (89) 2423990-20

www.online-usv.de

Italy

ONLINE UPS-Systems S.r.l.
Via Ferruccio Gilera 110
I-20862 Arcore (MB)

Phone +39 (039) 2051444
Fax +39 (039) 2051435

www.online-ups.it

Switzerland

ONLINE USV-Systeme AG
c/o POTESTA AG
Hertistrasse 29
8304 Wallisellen (Zürich)

Phone +49 (89) 242399010
Fax +49 (89) 242399020

www.online-usv.ch

Content

User manual	1
1. Introduction.....	5
2. Safety warnings	7
3. Installation	8
3.1 Checking the delivery	8
3.2 Unpacking the UPS system	8
3.3 Checking the accessories	9
3.4 XANTO 6000 and XANTO 10000: Installation as tower, connecting battery	9
3.5 XANTO 6000 and XANTO 10000: Installation in rack, connecting battery	11
3.6 Installation of XANTO 10000 3/1 – 20000 3/1, connecting the battery	13
3.7 Electrical installation for single system.....	14
Recommended cable cross sections	14
Terminal strip	15
3.8 Getting started single system.....	16
3.9 Electrical installation for parallel system	18
Electrical installation for redundant / parallel system	18
3.10 Quick start for parallel system	23
4. Operation.....	26
4.1 Control panel	26
4.2 LED indicators	27
4.3 Display and menu.....	28
4.4 Settings	31
4.5 Operating statuses	34
5. Communication and interfaces.....	38
5.1 RS 232 and USB interface	38
5.2 Slot for interface cards	39
5.3 Emergency Power Off (EPO) function	39
5.4 DataWatch software	41
6. Maintenance	43
6.1 Care and maintenance	43
6.2 Storage.....	43
6.3 When to change the batteries	43
6.4 Replacing the batteries	44
6.5 Testing the new batteries	45

6.6	Disposing of the old batteries or UPS system.....	45
7.	Troubleshooting.....	46
7.1	Error codes.....	46
7.2	Warnings.....	47
7.3	Troubleshooting.....	48
7.4	Muting the alarm.....	49
7.5	Support.....	50
8.	Technical data.....	51
8.1	List of device types.....	51
8.2	Dimensions and weight.....	51
8.3	Electrical connections.....	51
8.4	Electrical specifications.....	52
8.5	Batteries and autonomy time.....	53
8.6	Rear view.....	54
8.7	CE confirmation.....	57
9.	Warranty.....	58

List of Illustrations

Figure 1:	XANTO 6000 – 10000 in the rack.....	6
Figure 2:	XANTO 6000 - 10000 as tower.....	6
Figure 3:	XANTO 10000 3/1.....	6
Figure 4:	XANTO 20000 3/1.....	6
Figure 5:	Foot mounting.....	10
Figure 6:	Installation of the rack/tower versatile model as a tower.....	10
Figure 7:	Removing the frontpanel.....	12
Figure 8:	Rotating the display.....	12
Figure 9:	Securing the mounting bracket.....	12
Figure 10:	Rack mounting.....	12
Figure 11:	XANTO 6000 / 10000 terminal strip.....	15
Figure 12:	XANTO 10000 3/1 terminal strip.....	15
Figure 13:	XANTO 20000 3/1 terminal strip.....	16
Figure 14:	Connection plan for operating two XANTO 6000 / 10000 in parallel.....	20
Figure 15:	Connection plan for operating two XANTO 10000 3/1 in parallel.....	20
Figure 16:	Connection plan for operating two XANTO 20000 3/1 in parallel.....	21

Figure 17: Block circuit diagram for parallel connection	22
Figure 18: Control panel	26
Figure 19: Display in normal mode	34
Figure 20: Battery mode display	34
Figure 21: Display in standby mode	35
Figure 22: Display in high-efficiency mode	36
Figure 23: Display in bypass mode	36
Figure 24: Display in frequency converter mode	37
Figure 25: RS-232 interface (DB-9 connector)	38
Figure 26: Emergency power off connector	40
Figure 27: Rear view of XANTO 6000 and 10000	54
Figure 28: Rear view of XANTO 10000 3/1	55
Figure 29: Rear view of XANTO 20000 3/1	56

List of tables

Table 1: Package contents	9
Table 2: Cable cross-sections	15
Table 3: Descriptions of display	27
Table 4: LED indicators	27
Table 5: Display	29
Table 6: Acoustic alarm	29
Table 7: Overview of operating status	31
Table 8: Configuration menu	33
Table 9: Pin assignment for RS-232 interface	38
Table 10: Interface cards	39
Table 11: Error codes	46
Table 12: Warnings	48
Table 13: Troubleshooting	49
Table 14: Overview of UPS systems and battery packs	51
Table 15: Dimensions and weight	51
Table 16: Electrical connections	51
Table 17: Electrical specifications	53
Table 18: Batteries	53
Table 19: Autonomy times (in minutes) at 50 / 100% load, pf=0.7	53

1. Introduction

ONLINE USV-Systeme AG (ONLINE) is one of the leading manufacturers of uninterruptible power supplies (UPS). Since 1988, the German company has focussed on the development, production, sale and support of UPS systems. Based on unit numbers sold, ONLINE products are the German number one in the UPS market and internationally recognised because of their top quality and excellent support.

The power supply often fails when you least expect it. There can also be significant fluctuation in the quality of the power supply. Network problems can lead to the destruction of critical data, data which is not backed up can be lost and hardware damaged. This means expensive repairs and downtime.

Models of the XANTO series are the best way of preparing for these kinds of scenarios. These UPS system offer top class power supply protection for your delicate electronic systems. They protect against the most common supply problems such as power outage, voltage blips, surge voltage and low voltage, voltage drops, interference, switching and voltage peaks, frequency deviations and harmonic distortion.

XANTO reliably protects your systems from power supply problems and the functionality of the devices is retained. As well as first-class performance and reliability, XANTO has the following unique benefits:

- True double conversion technology (VFI-SS-111)
- Pioneering power factor 1.0 (1 kVA = 1kW)*
- Pure sinewave output voltage
- Redundancy function for double safety
- Parallel operation for power increase
- Frequency converter mode
- Automatic and manual bypass
- Scalable autonomy time with additional battery packages
- Efficiency of up to 98 %.
- Rack/Tower versatile model at 6,000VA and 10,000VA with just 4 HU
- Battery deep-discharge-protection
- Cold start function, starts the UPS system without utility power
- Switchable output sockets to extend the autonomy time for critical loads (not X6000 and X10000)

INTRODUCTION

- RS-232 and USB interface
 - Slot for optional SNMP adapter or AS400- / dry-contact interface-card
 - Emergency-off function (EPO = Emergency Power Off)
 - Built-in maintenance bypass (not X6000, X10000)
 - 2 years warranty incl. battery and 24h advance replacement
- * XANTO 10000 3/1 and XANTO 20000 3/1 only powerfactor 0.9



Figure 1: XANTO 6000 – 10000 in the rack



Figure 2: XANTO 6000 - 10000 as tower

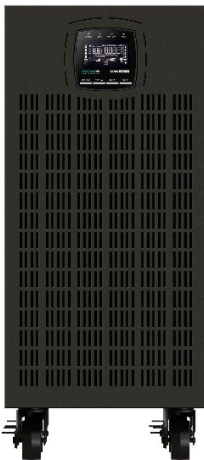

Figure 3: XANTO 10000 3/1



Figure 4: XANTO 20000 3/1

2. Safety warnings

This manual contains important instructions that you must follow during the installation and maintenance of the UPS system and the batteries. Please read all the instructions in the manual before working with the device. Keep the manual in a safe place.



CAUTION

- The UPS system carries life-threatening voltages. All repair and maintenance work must be carried out by customer service personnel.
- The UPS system has its own energy source (batteries). The output of the UPS system can be live even when the UPS system is not connected to a source of alternating current.
- In order to reduce the risk of fire or electric shock, the UPS system may only be installed in buildings with controlled temperature and air humidity in which there are no conductive contaminants. The ambient temperature must not exceed 40°C. The UPS system must not be operated near water or in extremely high air humidity (>90%).
- Before transporting the UPS system, make sure that it is disconnected from the power supply and switched off.
- Batteries can pose a risk of electric shock or catch fire as a result of high short circuit current. Please take the necessary precautionary measures. Maintenance must be carried out by qualified personnel who are trained in handling batteries and have good knowledge of the necessary precautionary measures, see Chapter 6 *Maintenance*. Keep unauthorised personnel away from batteries
- Batteries must be disposed of properly. Local regulations must be taken into consideration.
- Batteries must not be burnt. There is risk of explosion.

3. Installation

3.1 Checking the delivery

Keep the transport box and the packaging material for the carrier or sales point. If parts of the system have been damaged in transit, submit a transport damage complaint to your supplier within 24 hours. If you only discover damage after accepting the device, please submit a complain for concealed damage.

3.2 Unpacking the UPS system

	CAUTION
	<ul style="list-style-type: none">• Unpacking the UPS system at a low ambient temperature can lead to the formation of condensation inside and outside the casing. Only install the UPS system if the inside and outside are completely dry (risk of electric shock).• The UPS system is very heavy (see Chapter 8 <i>Technical data</i>). Be careful when unpacking and transporting the UPS.

	PLEASE NOTE
	<p>Move and open the packaged UPS system carefully. Leave the components in their packaging until they are installed.</p>

To unpack the UPS system and accessories:

1. Open the external box and take the accessories packed with the UPS system out.
2. Carefully lift the UPS system out of the external box. This may require two people under some circumstances.
3. Place the UPS system in a protected, adequately ventilated position which is free of humidity, flammable gasses and corrosion.

3.3 Checking the accessories

Description	XANTO 6000	XANTO 10000	XANTO 6000 battery pack	XANTO 10000 battery pack	XANTO 10000 3/1	XANTO 20000 3/1	XANTO 10000 / 20000 battery pack
19"mounting bracket (left and right)	2	2	2	2			
Feet for tower mounting (sets)	2	2					
Extension for feet for tower fitting			2	2			
USB interface cable	1	1			1	1	
Parallel cable	1	1			1	1	
Synchronisation cable (share current)	1	1			1	1	
Battery cable			1	1		1	1
Quick start guide	1	1	1	1	1	1	1
DataWatch software*							
Manual*							

*Download from www.online-ups.com

Table 1: Package contents

3.4 XANTO 6000 and XANTO 10000: Installation as tower, connecting battery

The UPS system is delivered fully assembled.

	CAUTION
The casing is very heavy (see Chapter 8 <i>Technical data</i>).	

1. Position the UPS system on an even, stable surface for its final location. The XANTO 6000 and 10000 UPS models have no internal batteries so the minimum configuration is always at least two housings: the UPS system and a battery pack.
2. If you install additional battery packs, also position them in their final position next to the UPS system.
3. For 6000 and 10000 UPS push them and its battery packs into the two feet from above (see Figure 6). Depending on the number of additional battery packs, you can also use the feet extensions for stabilisation (supplied with the battery packs). Make sure the distance between the two feet is as great as possible to ensure stability.



Figure 5: Foot mounting

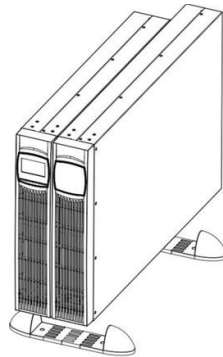

Figure 6: Installation of the rack/tower versatile model as a tower

Connecting additional battery packs

1. In order to install additional battery packs, remove the covers to connect the battery packs on the back of the UPS system and the battery packs, see Chapter 8.6 *Rear view*. If you are installing multiple battery packs, remove all the covers apart from the “V DC Input” cover on the last battery pack. Keep the covers and the screws.
2. Connect all plug connections between the battery packs and the UPS system. This involves connecting the “VDC Output” on a battery pack with the “VDC Input” on the upstream battery pack.

The battery pack connected directly to the UPS system is connected to the “VDC Input” on the UPS system. Connect each of the earth conductors on the battery cable with the housing of the UPS system and the battery pack. A maximum of four additional battery packs can be connected to the first standard battery pack on the UPS system.

3. Enter the number of battery packs used in menu no. 7 (see Chapter 4.4 *Settings*).
4. Continue the getting started process (see Chapter 3.8 *Getting started single system*)

3.5 XANTO 6000 and XANTO 10000: Installation in rack, connecting battery

The UPS system is delivered fully assembled.

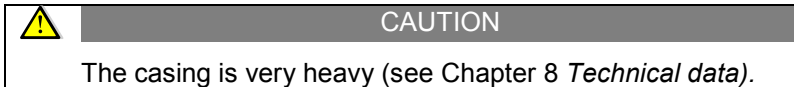

Optional slide rails (serial no. Rack Kit) are available for installation in the rack. The slide rails fit 48 cm (19 inch) racks with a depth of 48 to 78 cm.

1. Fit the rack kit (separate assembly instructions provided with the rack kit).
2. The next step is to adjust the display direction of the UPS system for horizontal rack installation. To do this, remove the front panel by pulling it forward. Then push the plastic catches on the display apart to release it. Rotate it 90 degrees and insert it back into the front panel.

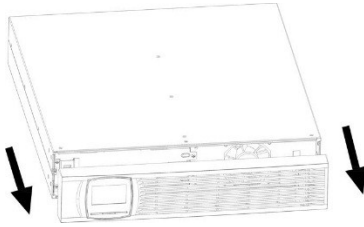

Figure 7: Removing the frontpanel

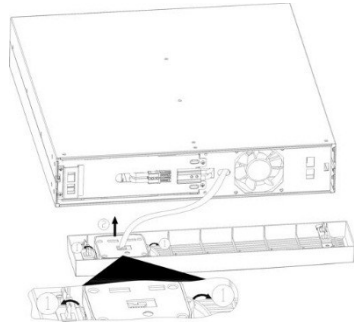

Figure 8: Rotating the display

3. Reverse the sequence to refit the front panel and repeat for the additional battery packs.
4. Align the mounting bracket (L = left and R = right) with the screw holes on either side of the UPS system and the battery packs and affix it using the M4 x 8 countersunk screws provided (see Figure 9).
5. Push the UPS system and the relevant number of battery packs into the rack.
6. Secure the mounting bracket of the UPS system and the battery packs in the rack (see Figure 10).



Figure 9: Securing the mounting bracket

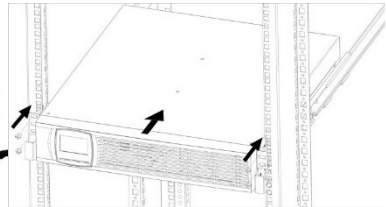

Figure 10: Rack mounting

Connecting additional battery packs

1. In order to install additional battery packs, remove the covers to connect the battery packs on the back of the UPS system and

the battery packs, see Chapter 8.6 *Rear view*. If you are installing multiple battery packs, remove all the covers apart from the “V DC Input” cover on the last battery pack. Keep the covers and the screws.

2. Connect all plug connections between the battery packs and the UPS system. This involves connecting the “VDC Output” on a battery pack with the “VDC Input” on the upstream battery pack. The battery pack connected directly to the UPS system is connected to the “VDC Input” on the UPS system. Connect each of the earth conductors on the battery cable with the housing of the UPS system and the battery pack. A maximum of four additional battery packs can be connected to the first standard battery pack on the UPS system.
3. Enter the number of battery packs used in menu no. 7 (see Chapter 4.4 *Settings*).
4. Continue the getting started process (see Chapter 3.8 *Getting started single system*).

3.6 Installation of XANTO 10000 3/1 – 20000 3/1, connecting the battery

The UPS system is delivered fully assembled.

	CAUTION
The casing is very heavy (see Chapter 8 <i>Technical data</i>).	

1. Position the UPS system on an even, stable surface for its final location.

The XANTO 20.000 3/1 UPS system has no internal batteries so the minimum configuration is always at least two housings: the UPS system and a battery pack.
2. If you install additional battery packs, position them in their final position next to the UPS system.
3. In order to install additional battery packs, remove the covers to connect the battery packs on the back of the UPS system and

the battery packs, see (Chapter 8.6 *Rear view*). If you are installing multiple battery packs, remove all the covers apart from the “V DC Input” cover on the last battery pack. Keep the covers and the screws.

4. Connect all plug connections between the battery packs and the UPS system. This involves connecting the “VDC Output” on a battery pack with the “VDC Input” on the upstream battery pack. The battery pack connected directly to the UPS system is connected to the “VDC Input” on the UPS system or to the battery terminals on the XANTO 20000 3/1. Connect each of the earth conductors on the battery cable with the housing of the UPS system and the battery pack.
5. A maximum of four battery packs can be connected to the XANTO 10.000 3/1 UPS system. For the XANTO 20.000 3/1, a maximum of three additional battery packs can be connected to the first standard battery pack on the UPS system.
6. Enter the number of battery packs used in menu no. 7 (see Chapter 4.4 *Settings*).
7. Continue the getting started process (see Chapter 3.8 *Getting started single system*).

3.7 Electrical installation for single system

	CAUTION
<ul style="list-style-type: none"> • Always connect the earth conductor first. • Do not make any unauthorised changes to the UPS system, as these could damage the system and invalidate the guarantee. • The UPS system must be connected to the mains voltage by a qualified electrician. 	

Recommended cable cross sections

	XANTO 6000	XANTO 10000	XANTO 10000 3/1	XANTO 20000 3/1
Input	6mm ²	10mm ²	10mm ²	16mm ²

Output	6mm ²	10mm ²	10mm ²	16mm ²
Earth conductor	6mm ²	10mm ²	10mm ²	16mm ²
Connection fittings	M5	M5	M5	M6
Cable plug, external max.	10mm	10mm	12mm	18mm
Fuse in battery pack	50A	50A	100A	100A

Table 2: Cable cross-sections

Terminal strip

1. Remove the cover on the terminal strip.
2. Connect the cables as shown in the diagram.

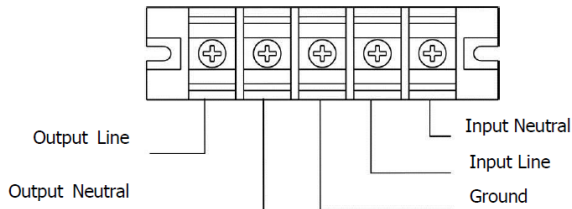

Figure 11: XANTO 6000 / 10000 terminal strip

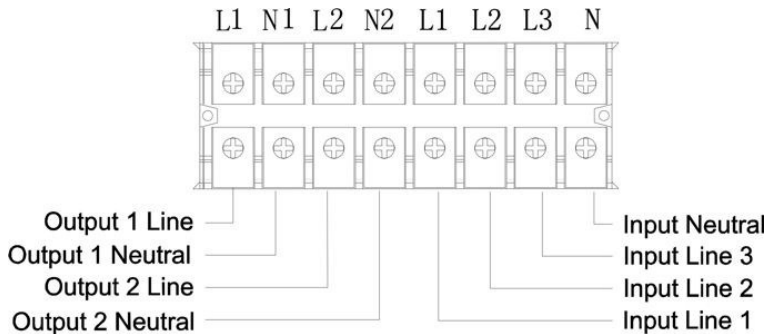

Figure 12: XANTO 10000 3/1 terminal strip

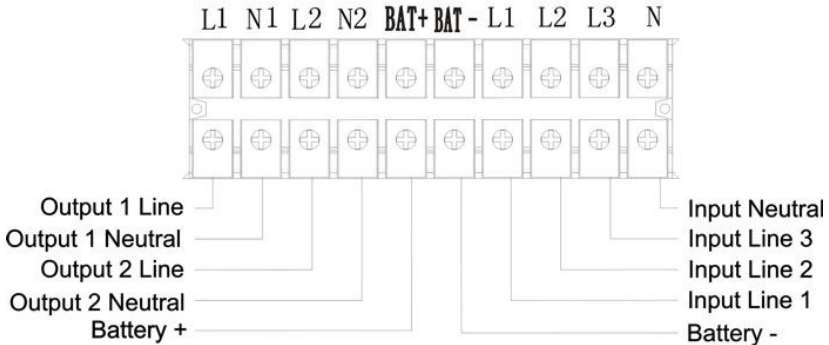

Figure 13: XANTO 20000 3/1 terminal strip

3. Replace the cover on the terminal strip.

3.8 Getting started single system

i
PLEASE NOTE

Make sure that the overall rated power of the loads connected does not exceed the capacity of the UPS system. The power consumption of inductive loads or laser printers can be very high, please take this into consideration when specifying your UPS system.

1. If you install additional battery packs, make sure they are properly connect (see Chapters 3.4 to 3.6) and the battery fuse on the back of the battery packs is switched on.
2. Connect the loads with the UPS system without switching them on. Make sure that the XANTO 10000 3/1 and 20000 3/1 UPS systems have two groups of output sockets. The programmable output sockets can be switched independently of the remaining sockets. The programmable output sockets are primarily designed for less critical loads which cannot be brought down using software. Critical loads should not be connected to the programmable output sockets.
3. Switch the supply voltage on and then switch the input switch on the back of the UPS system to “ON”. The fan starts working.

The display on the UPS system lights up and shows “Sb” after a short initialisation phase.

4. Hold the “ON / ←” button on the UPS system down until you hear a short beep.
5. The UPS system carries out a self-test, after which “OK” appears on the display. The UPS system is now operating in normal mode and supplying the loads with reliable power.
6. If an additional emergency off switch has been installed, the emergency stop function needs to be tested.
7. Switch the loads on one by one.



PLEASE NOTE

The internal batteries charge up to 90% of their full capacity in five hours. ONLINE recommends charging the batteries for 48 hours after installation or extended periods of non-use.

The batteries start to charge as soon as the UPS system is connected to the utility power and supplied with power, irrespective of the operating mode.

Starting in battery mode

1. Hold the “ON / ←” button on the UPS system down until you hear a beep.
2. The UPS system starts and then shows b4 on the display to indicate that the bypass is outside the tolerance.
3. Then press the “ON / ←” button until you hear another beep. The UPS system indicates the start process by showing “ON” in the display, then starting the self-test and then switching to battery mode (see Chapter 4.5 *Operating statuses*) and supplies the loads connected with reliable electricity.
4. If the △ display is lit, fix all warnings (see Chapter 7.3 *Troubleshooting*) and restart the UPS system.

Switching off

1. Hold the “OFF / ESC” button on the UPS system down for 2 seconds. When the continuous beep ends, the UPS system switches to standby mode.



PLEASE NOTE

If the “OFF / ESC” button is released after less than 2 seconds, the unit is not switched off.

2. Switch the input switch on the back of the UPS system to “OFF” and then switch the supply voltage off. The display on the UPS system goes out after a short time and the UPS system switches off completely.

3.9 Electrical installation for parallel system

The XANTO 6000 / 10000 and XANTO 10000 / 20000 3/1 UPS systems enable redundancy and parallel operation.

Redundant operation:

The redundant mode offers dual security. Up to three UPS systems are operated in parallel. If a UPS system fails, the remaining systems take over with no interruption. Redundancy mode is possible up to the rated power of the UPS system (6000VA, 10,000VA, 20,000VA). If this power is exceeded, the group automatically switches to parallel mode. Parallel mode is indicated in the UPS menu by PAxxx.

Parallel mode:

This mode enables an increase in the power range of the UPS system, but there is no redundancy. In parallel mode, for example, a XANTO 6000 could be connected to two more XANTO 6000 units to increase the overall power available to 18,000VA.

Electrical installation for redundant / parallel system



PLEASE NOTE

- A maximum of three UPS systems (with the same output power) can be connected as an n+1 group.
- All UPS system must be connected to the same utility power.

- All UPS systems require the same number of batteries (internal batteries or additional battery packs). Operation with shared batteries is not permitted.
- The UPS systems must have identical menu configurations (output voltage and frequency, frequency converter mode deactivated, bypass activated).
- For information on cable cross-section, fuses and terminal strips, see chapter 3.7.

1. Connect the inputs and outputs of the UPS systems to the individual circuit breakers (see Figure 14 to Figure 16). Power switches are not included, they are:
 - 2-pole for L and N on XANTO 6000 / 10000 and as output switches for XANTO 10000 / 20000 3/1
 - 4-pole for L1-L3 and N on XANTO 10000 / 20000 3/1 as input switches

Make sure that all power switches are open.

2. The connected cables for input and output must have at least the cross-section shown in Table 2: *Cable cross-sections*.
3. ONLINE also recommends an additional maintenance switch (not included) to install the group (see *Figure 17: Block circuit diagram for parallel connection*).
4. Connect the UPS systems with the parallel and synchronisation cable (share current). The UPS systems must not be switched on.



PLEASE NOTE

- If the cables are greater than 10 m in length, the cable lengths to the UPS systems must not differ by more than 20%.
- If the cables are greater under 10 m in length, the cable lengths to the UPS systems must not differ by more than 5%.

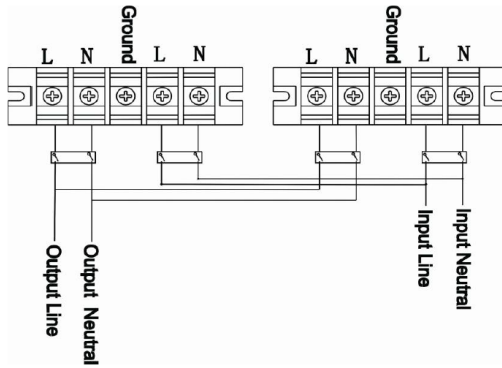

Figure 14: Connection plan for operating two XANTO 6000 / 10000 in parallel

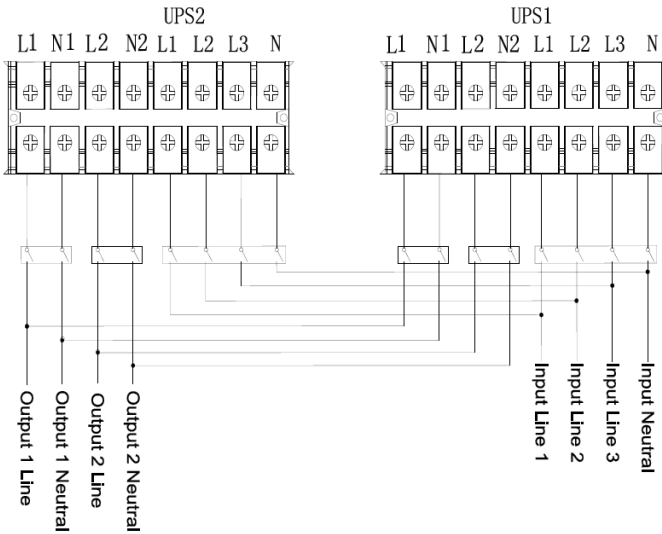

Figure 15: Connection plan for operating two XANTO 10000 3/1 in parallel

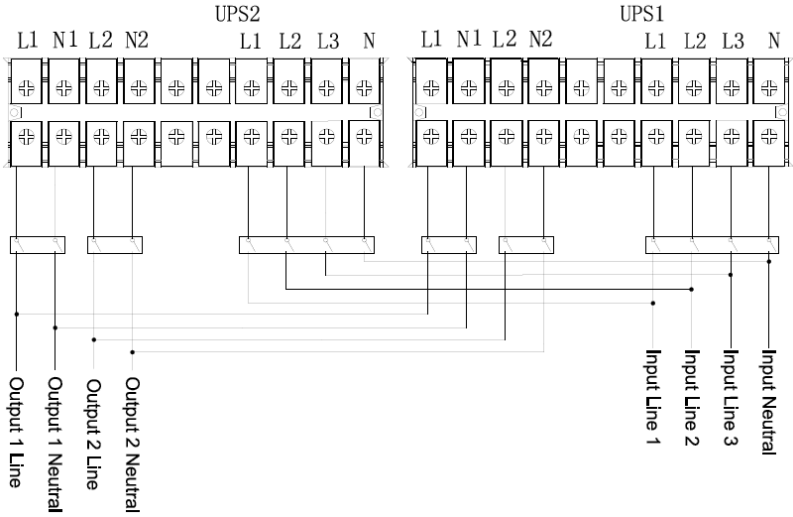

Figure 16: Connection plan for operating two XANTO 20000 3/1 in parallel

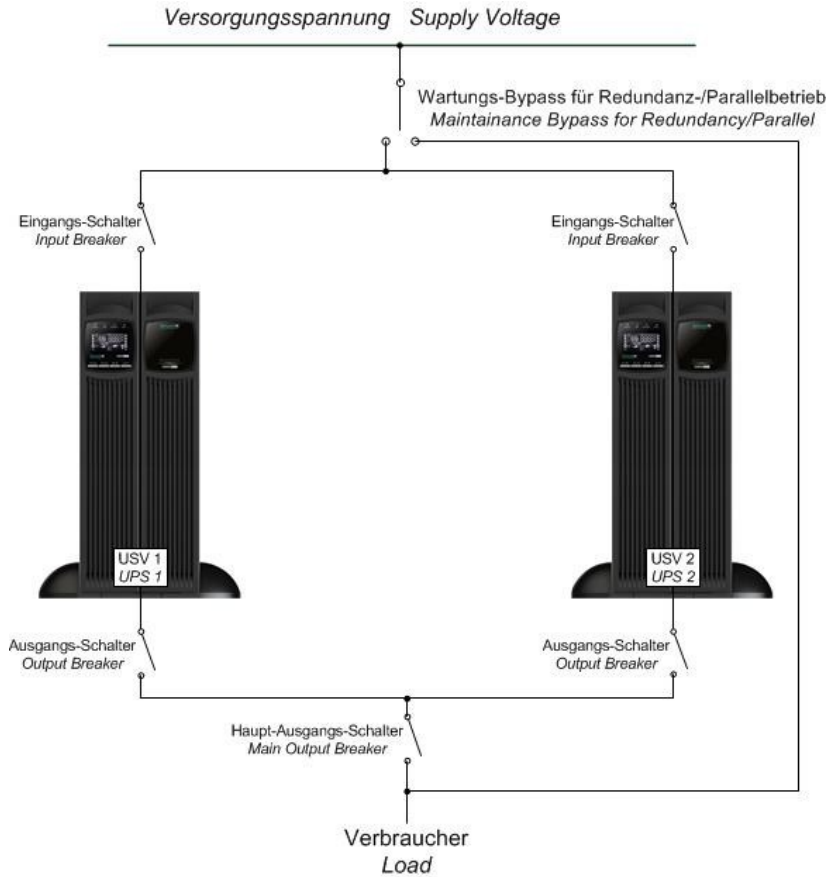



Figure 17: Block circuit diagram for parallel connection

3.10 Quick start for parallel system

1. Make sure that the menu settings for all the UPS systems grouped in parallel are identical and the battery packs are correctly connected (see Chapter 3.4 to 3.6). The battery fuse on the back of the battery packs must also be switched on.
2. If you switch the power switch on the input for a UPS system on, leave the power switch on the output of the UPS system switched off. Then switch the input switch on the back of the UPS system to “ON”. The fan starts working. The display on the UPS system lights up and shows “Sb” after a short initialisation phase.
3. Activate the bypass (see Chapter 4.4 *Settings*).
4. Switch the UPS system on. To do this, hold the “ON / ←” button on the UPS system down until you hear a beep.
5. Measure the output voltage of the UPS system using a multimeter. If the output voltage measured deviated from the output voltage selected as in Chapter 4.4 *Settings*, menu 1, by more than 1.5V, adjust it using menu 10. If the output voltage cannot be adjusted to a difference of less than 1.5V, please contact technical support (see Chapter 7.5 *Support*).
6. After adjusting the output voltage, switch the UPS system off again and repeat steps 1 to 5 for the other UPS system(s).
7. Once you have successfully adjusted your output voltage for all the UPS systems working in the parallel group. Leave the power switches on the UPS outputs switched off. Make sure that the menu settings for all the UPS systems working in the parallel groups are identical. This does not include the previous adjustment of the output voltage using menu 10.
8. Now switch the power switches on the UPS outputs on.
9. Check that all UPS systems have detected the parallel mode. The display PAXxx should appear temporarily on the display, press ▼ to display PAXxx if necessary. If this display does not appear, check the parallel and synchronisation cable is properly connected.

10. Switch both UPS systems on using the ON button. After a short synchronisation time, both UPS system switch into normal mode at the same time. Parallel mode has been successfully started.
11. In order to switch off the UPS systems, the “OFF / ESC” buttons on all the UPS systems must be pressed. Pressing only one “OFF / ESC” button does not switch the UPS systems off.

	PLEASE NOTE
<ul style="list-style-type: none"> • The UPS systems in the parallel group can be operated either with or without a bypass in accordance with Chapter 3.9. 	

Cold-starting the parallel system:

As well as the commissioning process described in Chapter 3.10 if input voltage is in place, the UPS systems can also be started on the battery with no input voltage. To do this, proceed as follows:

1. Before the UPS systems can be started in parallel mode without input voltage, make sure that all the steps of the initial start-up process (see Chapter 3.10) have been completed.
2. Switch the input voltage on the back of the UPS systems and the battery fuse on the back of the battery pack to “ON”.
3. Switch the power switches on the UPS outputs on.
4. Hold the “ON / ←” button on all UPS systems in the parallel group down until you hear a beep.
5. The UPS systems start and then show  on the display to indicate that the bypass is outside the tolerance.
6. Hold the “ON / ←” button on all UPS systems in the parallel group down until you hear another beep. The UPS systems indicate the start process by showing “ON” in the display and then start the self-test process. They then switch to battery mode (see Chapter 4.5 *Operating statuses*) and supply the loads with reliable power.

7. In order to switch off the UPS systems, the “OFF” buttons on all the UPS systems must be pressed. Pressing the “OFF” button does not switch the UPS systems off.

Adding another UPS system to the parallel system:

The parallel system can work with a total of three UPS systems. In order to add another UPS system, the load needs to be powered down and the UPS systems switched off.

Removing UPS systems from the parallel system:

In order to remove one or two UPS systems from the parallel system, switch the UPS system in question into bypass mode. To do this, press the OFF button twice. The bypass LED and the rectifier symbol flash alternately. In bypass mode, deactivate the power switches on the input and output of the UPS system. Once the UPS system has shut down, open the battery fuse on the back of the battery pack, remove the parallel and synchronisation cable from the UPS system and then remove the UPS system from the parallel group.

If the bypass voltage is not within the tolerance, the UPS system cannot be removed from the parallel group as described above. In this case, the load must be properly powered down and the UPS systems switched off.

4. Operation

4.1 Control panel

The UPS system has a control panel with 4 buttons, a graphic display and 4 LEDs (see Figure 18).

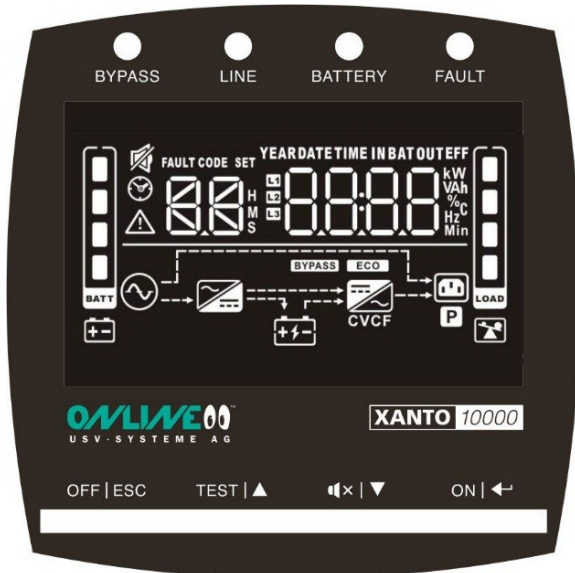



Figure 18: Control panel

Button	Function	
ON / ←	Switch on	In standby mode: Press button for more than 2 seconds
	Selection	In configuration mode: Press the button to apply the selection
OFF / ESC	Switch off	In normal mode: Hold the button down for longer than 2 seconds (switch to standby or bypass mode, depending on the menu setting)
TEST / ▲	Self-test	In normal or frequency converter mode: Press button for more than 2 seconds
	Back to top	In configuration mode: In previous menu

⏏ / ▼	Configuration mode	In standby or bypass mode: Press button for longer than 2 seconds to start configuration mode
	Alarm signal OFF	In battery mode: Press button for more than 2 seconds, not valid if there are warning or error messages
	Down	In configuration mode: Back to menu
▲ / ▼	Cancel	In configuration mode: Press button to go back to the last menu option

Table 3: Descriptions of display

	PLEASE NOTE
<p>During the function or battery test, the batteries must be completely discharged and the UPS system must be in normal mode.</p>	

4.2 LED indicators

The four LED displays above the display indicate the following operating statuses:

	BYPASS	LINE	BATTERY	FAULT
UPS starting up	●	●	●	●
Standby mode	○	○	○	○
Bypass mode	●	○	○	○
Normal operating mode	○	●	○	○
Battery mode	○	○	●	○
Frequency converter mode	○	●	○	○
Self-test	●	●	●	○
High-efficiency mode	●	●	○	○
Error	○	○	○	●

Table 4: LED indicators

4.3 Display and menu

Symbol	Description	Function
	Input, battery, temperature, output, load	Pressing the ▲ or ▼ button in normal mode displays the following measurements: Input voltage (for XANTO 10000/20000 3/1 L1, L2, L3), input frequency and current, battery voltage and capacity, output voltage, current and frequency.
	Autonomy time	Display of remaining autonomy time
	Load display	Displays the current load. Each segment represents 25%. If all the segments are lit up, the UPS system is working at 100% load.
	Overload	Indicates that the UPS system is overloaded
	Programmable output sockets	Indicates active programmed output sockets (XANTO 10000 / 20000 3/1)
	Battery display	Indicates the current battery capacity. Each segment represents 25%. If all the segments are lit up, the battery is 100% charged.
	Battery empty	Battery symbol underneath battery display: Flashing indicates the battery capacity is coming to an end.
	Configuration	Display of configuration menu options. For further information, see Chapter 4.4 Settings
	Error	Display of error or alarm code. For complete table, see chapter 7.1 <i>Error codes</i>
	Acoustic alarm	Displays a deactivated acoustic alarm, silent
	Input voltage	The UPS input is connected to the mains voltage
	Rectifier	Rectifier active, battery charging
	Inverter	Active inverter, the loads on the output sockets are UPS-protected









Symbol	Description	Function
	Output sockets	Active UPS output
	Battery	Battery symbol in DC link: UPS system in battery mode
	Battery charging	Battery symbol in DC link: Battery in charging mode
BYPASS	Bypass mode	Bypass mode, the loads are supplied directly by the utility power without UPS protection
ECO	High-efficiency mode	The UPS system is working in high-efficiency mode
CVCF	Frequency converters	The UPS system is working in frequency converter mode

Table 5: Display

Alarm	Description
Every 10 seconds	UPS system in bypass mode
Every 5 seconds	UPS system in battery mode
Every 2 seconds	Battery voltage low
Every second	Overload
Continuous tone	Error

Table 6: Acoustic alarm

Abbreviation	Display	Description
AAT		Time in battery mode
AC		Active Closed
AD		Increase set value
AO		Active Open
BF		Battery Fault

OPERATION



BL	bl	Battery Low
BP	BP	Battery pack
BR	bR	Battery Replace
BY	by	Bypass not within tolerance
CH	CH	Charger
DIS	diS	Disable
EAT	EAt	Remaining autonomy time
EE	EE	EEPROM Error
ENA	ENa	Enable
EP	EP	Emergency power off / EPO
FU	FU	Bypass frequency not stable
NC	nC	Battery not connected
OC	OC	Battery overcharged
OI	OI	Input current too high
OK	OK	OK
OL	OL	Overload
ON	On	On
Sb	Sb	Standby
SD	Sd	Power down UPS / Shutdown
SU	Su	Reduce set value

TP	EP	Temperature
----	----	-------------

Table 7: Overview of operating status

4.4 Settings

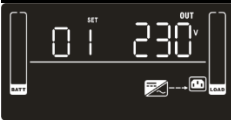
1. Open configuration menu: Switch to standby mode or bypass mode and press ▼ button for 2 seconds.
2. Selection of menu options: Press ▼ or ▲ button until you reach the menu option you want (see Table 8: *Configuration menu*).
3. Select menu option: Press ON / ← button.
4. Change menu setting: Press ▼ or ▲ button until you reach the setting you want (see Table 8: *Configuration menu*).
5. Confirm setting: Press ON / ← button.
6. Takes you one step back in the menu or exits the configuration menu: Press the ▼ and ▲ buttons at the same time. You can also exit the configuration menu from menu “00”.

Setting	Available options	Standard
	Select output voltage: [208] = 208V [220] = 220V [230] = 230V [240] = 240V	“230V”
	Frequency converter mode: Switch frequency converter mode on or off [ENA] = on (bypass mode not possible) [DIS] = off	“DIS”
	Output frequency: If frequency converter mode is possible, the output frequency is in normal and battery mode [50] = 50 Hz [60] = 60Hz	“50”

	<p>High-efficiency mode: [ENA] = on [DIS] = off</p>	<p>“DIS”</p>
	<p>Bypass mode: If the UPS system is switched off, it is switched to bypass instead of standby mode. [ENA] = Enabled [DIS] = Disabled</p>	<p>“DIS”</p>
	<p>Battery deep discharge protection: Shutdown of all output sockets after time defined here. [0 – 999] = Shutdown after 0 to 999 minutes. [DIS] = Shutdown time dependent on battery capacity. Attention: If the setting is [0], shutdown is after 10 seconds.</p>	<p>“DIS”</p>
	<p>Number of additional battery packs: Selection of correct number of additional battery packs. For XANTO 6000, 10000 and 20000 3/1 default setting = 1, for XANTO 10000 3/1 default setting = 0</p>	
	<p>Autonomy time Select from display [AAT] = Time in battery mode [EAT] = Remaining autonomy time</p>	<p>“EAT”</p>
	<p>Emergency power off function: [AO] = active open, emergency power off is active with emergency power off contact open [AC] = active close, emergency power off is active with emergency power off contact closed</p>	<p>“AO”</p>
	<p>Menu only active in parallel mode with direct menu access from normal mode! Fine adjustment of inverter volume: Increases or reduces the output voltage [Ad] = 0 – 6.4V [Ad] = 0 – 6.4V</p>	<p>“0”</p>



Menu only active in parallel mode with direct menu access from normal mode!

"0"

Fine adjustment of output voltage on LCD:

Increases or reduces the output voltage shown on the display, no influence on the actual output voltage.

[Ad] = 0 – 6.4V

[Ad] = 0 – 6.4V



Exit:

Exiting configuration menu

The following functions are only supported by XANTO 10000 3/1 and 20000 3/1.



Operating mode:

The UPS system can be operated either on the 3/1 or on the 1/1 supply network.

[DIS] = The UPS must be operated on the 3/1 supply network with 120° phase adjustment between the cables.

[ENA] = The UPS system can be operated either on the 3/1 or on the 1/1 supply network. For 1/1, L1 - L3 are supplied by the same phase.



Programmable output sockets:

"DIS"

[ENA] = Enabled

[DIS] = Disabled



Shutdown time for programmable output sockets:

"999"

[0 - 999] = Shutdown of programmable output sockets in battery mode after time defined here.

Only available if "Programmable output sockets = "active" and UPS system restarted after setting the time.

Table 8: Configuration menu

4.5 Operating statuses

The status of the UPS system is displayed on the control panel.

Normal operating mode

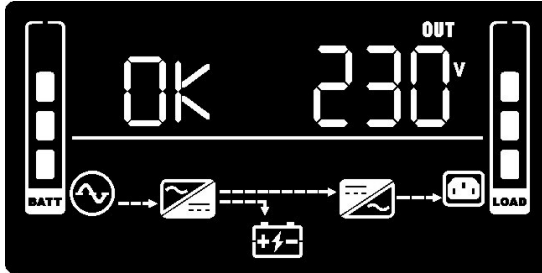

Figure 19: Display in normal mode

In normal mode, “OK” is shown on the display and the UPS system is fed by the utility power. The UPS system monitors the batteries and charges them as required. The loads connected are supplied with reliable UPS power.

Battery mode

In battery mode, the following display appears:



Figure 20: Battery mode display

At the same time, an acoustic alarm every 5 seconds indicates that the loads connected are being supplied with battery power.

If the battery charge level is low in battery mode, “BL” is shown on the display.  starts to flash and the alarm sounds every second. The remaining autonomy time is low. Close all applications, as the UPS is about to shut down automatically.

If the battery is exhausted, the UPS system shuts itself down. All displays and the alarm are switched off.

If the utility power is restored after the UPS system has shut down, the UPS is automatically restarted. The batteries are charged up and the loads connected are supplied with power.

Standby mode

If the UPS system is switched off and the power supply cable is connected, the UPS system works in standby mode. The following display appears:



Figure 21: Display in standby mode

No power is available for the loads connected. The battery is charged if necessary.

High-efficiency mode

In high-efficiency mode, the loads are supplied via the bypass. The inverter is always ready for use at the same time. If the utility power is outside the tolerance, there is a smooth transition to normal mode.

The battery is charged in high-efficiency mode.

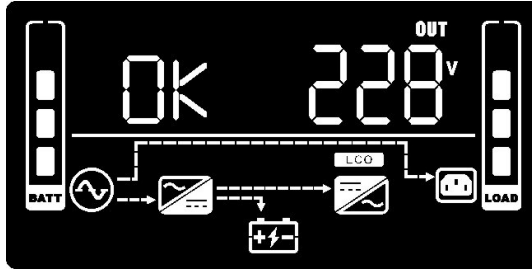

Figure 22: Display in high-efficiency mode

Bypass mode

Bypass mode can be activated in normal mode by pressing the ▼ and ▲ buttons at the same time 2 seconds. To switch back into normal mode, again press the ▼ and ▲ buttons until the beeping stops. In the event of an overload, the UPS system automatically switches into bypass mode. A beep sounds every 10 seconds.

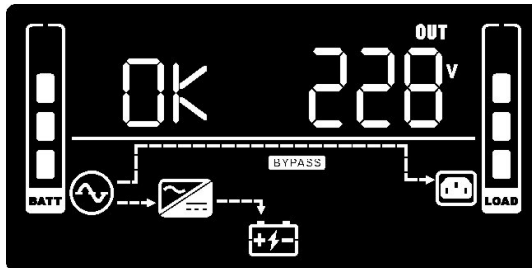

Figure 23: Display in bypass mode

Frequency converter mode

In addition to regular UPS mode, the UPS system can also operate as a frequency converter. This involves providing the loads with a constant output frequency of either 50 or 60Hz. Bypass is not available in frequency converter mode. The battery is charged.

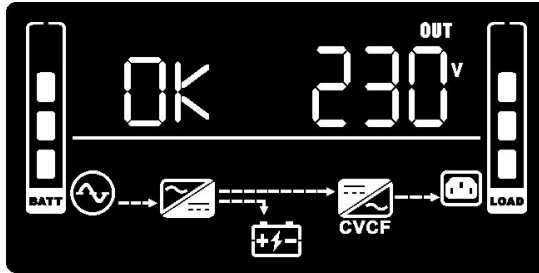

Figure 24: Display in frequency converter mode

Parallel operating mode

After successfully installation of a parallel setup, the first UPS (Master) shows on their display PA001. The other UPS systems (Slaves) shows PA002 or PA003.



Abbildung 1: Parallel operation mode

5. Communication and interfaces

5.1 RS 232 and USB interface

In order to establish communication between the UPS system and a computer, connect the computer using a suitable data cable (cable provided) to the RS-232 or USB interface on the UPS system (see Chapter 8.6 *Rear view*).

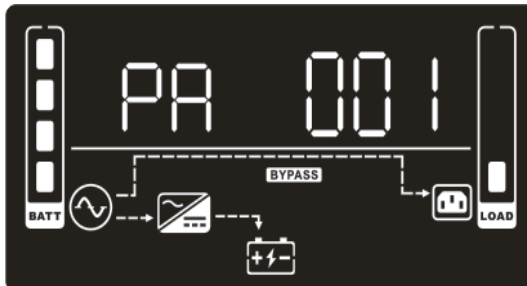
	PLEASE NOTE
The RS-232 and USB communication interfaces cannot be used at the same time.	

The UPS system can then exchange data via the DataWatch software (see Chapter 5.4).

The assignment of the cable connection pins for the RS-232 communications interface is shown in Figure 25, while the functions of the connection pins can be found in Table 9.

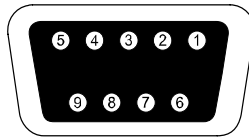

Figure 25: RS-232 interface (DB-9 connector)

Pin	Function
1	Not used
2	Send data (TxD)
3	Receive data (RxD)
4	Not used
5	Mass
6, 7, 8, 9	Not used

Table 9: Pin assignment for RS-232 interface

5.2 Slot for interface cards

The XANTO features a slot (see Chapter 8.6) for the following interface cards:

Product no.	Description
DW7SNMP30	SNMP adapter Basic The SNMP adapter communicates via TCIP/IP with the loads attached to the network.
DW5SNMP30	SNMP adapter Professional Works like Basic, but with additional interface for temperature sensor and building management.
DWAS400DC	AS400 relay card Combined slot card for optional communication with IBM AS400 servers or individual use of relay contacts. The following messages/contact outputs are available: Normal mode, standby mode, battery mode, battery voltage low, bypass mode, collective error, input for UPS shutdown.

Table 10: Interface cards

	PLEASE NOTE
The interface cards installed in the slot can be used in parallel with the RS-232 or USB communication.	

5.3 Emergency Power Off (EPO) function

The Emergency Power Off (EPO) function is used to remotely shut down the UPS system and connected loads immediately. This means removing the bridge on the emergency power off connector (back of UPS system, see Figure 25) and connecting an external emergency power off switch.

Cross section of connecting cable = 0.5 - 2.5mm² (AWG 13 - 20)

Recommended cross-section of connecting cable = 1.5mm² (AWG 15)

	CAUTION
<ul style="list-style-type: none">• The emergency power off switch must not be connected to circuits which are connected to the utility power. Reinforce insulation from the network is required. The emergency power off switch must be designed for at least 60V DC / 30V AC and 20 mA.• Depending on the programming via the UPS menu (see Chapter 4.4 Settings), either an opener or a closer can be used. The emergency power off function must be active for at least 250ms for proper operation.• If the emergency power off function is activated, the input voltage of the UPS system also needs to be interrupted.• The emergency power off function is only used to shut down the UPS voltage on an electronic basis.	

	PLEASE NOTE
<ul style="list-style-type: none">• Leave the plug in the emergency power down plug of the UPS system connected if you do not need the emergency power off function.• Always test the emergency power off function before connecting a critical load. This avoids the load being switched off accidentally	

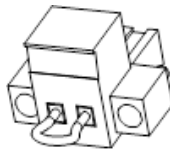

Figure 26: Emergency power off connector

See Chapter 8.6 *Rear view* for the position of the emergency power off connector.

5.4 DataWatch software

The XANTO range is supplied as standard with DataWatch, a comprehensive software solution for shutting down and managing the PC or server system and for monitoring the XANTO and the power supply network. To ensure you are always working with the latest version of DataWatch, please download it from the download area of www.online-usv.de.

DataWatch works in the backdrop and is in constant communication with the XANTO via the RS-232, USB or network protocol. The most famous of all functions: Automatic data backup including the shutdown of running applications and the proper shutdown of the whole system by means of a freely configurable shutdown routine. At the same time, DataWatch has a comprehensive messaging system, time-controlled test routines and event logging.

DataWatch supports all current operating systems.

As a client/server application, DataWatch works in networks and on local workstations. Based on optional RCCMD agent (Remote Console Command), multiple servers connected to a UPS system can be addressed and controlled across the network without additional hardware.

Overview of functions:

	UPS / LCD	DataWatch software
Display of input voltage (for XANTO 10000/20000 3/1 L1, L2, L3), input frequency and current, battery voltage and capacity, output voltage, current and frequency	X	X
Switching the UPS system on/off, changing the mode (normal, standby, bypass, high-efficiency, frequency converter mode)	X	X
Changing the output voltage	X	X
Switching on/off and configuration of the frequency converter mode	X	X
Switching high-efficiency mode on/off	X	X
Switching bypass on/off instead of standby	X	X
Switching on/off and configuration of the battery deep discharge protection	X	X
Configuration of additional battery packs	X	X

COMMUNICATION AND INTERFACES

Change the autonomy time display	X	X
Switching on/off and configuration of the emergency power off function	X	X
Setting the inverter output voltage	X	X
Manual restart of the UPS system	X	X
Display of battery error	X	X
Extended display of total duration of battery mode		X
Display of serial number		X
Local server shutdown via RS-232 / USB interface		X
Multi server shutdown via TCP/IP		X
SNMP proxy agent		X
Sending e-mail, SMS, broadcast message		X
Manual 10 second test	X	X
Manual full test		X
Auto self-test		X
Switch battery mode alarm on/off	X	X
Switch alarm on/off completely		X
Reset UPS system to factory settings		X
Display warning, alarm and error messages	X	X
Chronological record, display and export (csv) of warning, alarm and error messages		X
Recording, display and export (csv) of voltage, current, frequency and temperature curves (data log chart)		X
Individual event programming		X

XANTO 10000 3/1 and XANTO 20000 3/1 only:

switching on/off and configuration of switchable output sockets	X	X
Changing the input voltage for optional operation of 3/1 or 1/1 supply network	X	X

6. Maintenance

6.1 Care and maintenance

To ensure a long service life of the system, the area around the UPA system should be kept clean and free of dust. If the area around the system is very dusty, clean the external surfaces of the system with a vacuum cleaner.

To ensure a long service life for the batteries, the ambient temperature should not exceed 25°C.

	PLEASE NOTE
<ul style="list-style-type: none">• Before transporting the UPS system, make sure that it is disconnected from the utility power supply and switched off.• The service life of a battery varies as a function of how often it is used, intensity of use and ambient temperature. Batteries which are used beyond their expected service life often have reduced autonomy times. Replace the batteries in good time to ensure the system always runs at optimum performance.	

6.2 Storage

If you intend to store the UPS system for an extended period, charge the battery every three months by connecting the UPS system to the utility power supply for five hours. The system should be stored in a cool, dry place.

6.3 When to change the batteries

If "BR" is shown on the display and an alarm signal sounds every 2 seconds, the batteries need to be replaced. Contact your reseller or ONLINE (www.usvshop24.de) to order new batteries.

6.4 Replacing the batteries



PLEASE NOTE

Do not replace the batteries while the UPS system is in battery mode.

To replace the batteries, the UPS system must be switched off, disconnected from the utility power and opened. The batteries cannot be hot swapped, or this is only possible in part for the XANTO 6000 and 10000 by replacing the battery packs.



CAUTION

- Maintenance work must be carried out by a qualified technician who is familiar with batteries and the necessary safety measures. Do not allow unauthorised personnel to handle the batteries.
- Batteries pose the risk of an electric shock or injury due to high short circuit current. Take the following safety measures:
 - remove watches, jewellery and other metal items
 - only use tools with insulated handles
 - do not place tools or metal components on the batteries
- The batteries must only be replaced with the same number of batteries of the same type.
- Batteries must be properly disposed of. When disposing of batteries, comply with the statutory regulations applicable in your location.
- Batteries must not be burnt. There is risk of explosion.
- Do not open or damage the battery or batteries. Battery acid can damage the eyes and skin and cause poisoning.

	CAUTION
<ul style="list-style-type: none"> • DANGER OF ELECTRIC SHOCK. Never make changes to the battery cabling or connections. Attempting to change the battery cabling yourself could lead to serious injury. • The batteries of the UPS system are very heavy. Be careful when handling heavy batteries. 	

6.5 Testing the new batteries

1. To charge the batteries, connect the UPS to the utility power for 48 hours.
2. In normal mode, hold the TEST / ▲ button for at least 2 seconds to start the self-test.
3. If the batteries are faulty, a warning is displayed automatically (see Table 12: *Warnings*).

	PLEASE NOTE
<p>The UPS system only starts a self-test when the batteries are fully charged and the UPS system is in normal mode with no active warning messages.</p>	

6.6 Disposing of the old batteries or UPS system

Find out from a local recycling centre how the old batteries or the UPS system should properly be disposed of. Old batteries can also be returned to ONLINE for disposal free of charge. Please contact Support (see Chapter 7.5 *Support*).

	CAUTION
<ul style="list-style-type: none"> • Batteries must not be burnt. There is risk of explosion. • Batteries must be disposed of properly. Find out about the local disposal regulations. • Do not open or damage the battery or batteries. Battery acid can damage the eyes and skin and cause poisoning. 	

7. Troubleshooting

The XANTO is designed for autonomous operation and automatically reports and problems in the display.

7.1 Error codes

Error code	Event
01	Error starting the DC link
02	DC link voltage too high
03	DC link voltage too low
04	Asymmetric interim circuit voltage
06	Converter overload
11	Error starting inverter
12	Inverter voltage too high
13	Inverter voltage too low
14	Short circuit in inverter output
1A	Negative current fault
21	Battery short-circuit
24	Inverter relay short-circuit
27	Battery voltage too high
28	Battery voltage too low
29	Battery fuse defective
2A	Short circuit on charger output
31	Bus communication error
36	Output signal current asymmetric in parallel mode
41	Temperature too high
42	CPU communication problem
43	Overload
45	Charger error
46	Incorrect configuration
49	Input voltage too high
60	Inverter overload
63	Inverter wave shape abnormal
6A	Battery switching error
6B	Current power factor correction error in battery mode
6C	Bus voltage changing too quickly

Table 11: Error codes

If the UPS system indicates one of the error codes listed above, please contact ONLINE support (see Chapter 7.5).











7.2 Warnings

Event	Symbol	Code	Alarm
Battery capacity low		bl	Warning sound every 2 seconds
Overload		OL	Warning sound every second
Input voltage too high		OI	2 warning sounds every 10 seconds
Battery not connected		NC	Warning sound every 2 seconds
Battery overcharged		OC	Warning sound every 2 seconds
Emergency power off active		EP	Warning sound every 2 seconds
Temperature too high		EP	Warning sound every 2 seconds
Charger error		CH	Warning sound every 2 seconds
Battery error		bf	Warning sound every 2 seconds
Fan fault		FF	Warning sound every 2 seconds
Different inputs in parallel mode		Ld	Warning sound every 2 seconds
Different bypass in parallel mode		bd	Warning sound every 2 seconds
Bypass voltage out of tolerance		by	Warning sound every 2 seconds
Bypass frequency not stable		FU	Warning sound every 2 seconds
UPS blocked after 3x overload in 30 minutes		Lb	Warning sound every 2 seconds
Replace battery		bR	Warning sound every 2 seconds
Input fuse faulty		Fb	Warning sound every 2 seconds
EEPROM Error		EE	Warning sound every 2 seconds

No boot loader available.			Warning sound every 2 seconds
---------------------------	---	---	-------------------------------

Table 12: Warnings

7.3 Troubleshooting

Operating status	Possible cause	Measure
The UPS system cannot be switched on, although there are no alarms and the input voltage is normal.	The input cable is not correctly connected to the input socket.	Check that both connectors are properly inserted in the sockets.
	The input cable has been accidentally connected to the UPS output sockets.	Connect the input cable to the UPS input.
The  and  symbols flash and an alarm is sounded every 2 seconds.	Emergency power off is active.	Check that the emergency power off connector is seated firmly and the wire jumpers match the menu settings in Chapter 4.4 (closed or open, depending on the jumper). Then press the OFF button for 2 seconds and then start the UPS system using the ON button.
The  ,  and  symbols flash and an alarm is sounded every 2 seconds.	The battery is not connected.	Check that the battery is properly connected (see Chapter 3.4 to 3.6). Then restart the UPS system using the ON button.
The  ,  and  symbols flash and an alarm is sounded every second.	The output load on the UPS system is too high.	Reduce the load on the UPS output sockets.
	The load on the UPS output is too high, loads are supplied via the bypass.	Reduce the load on the UPS output sockets. The UPS is then automatically switched back to normal mode.
	If the overload persists, the UPS switches back to bypass mode.	Reduce the load on the UPS output and then restart the UPS.
The  and  symbols and the error code 43 are shown in the display. A permanent alarm sounds.	UPS system shutting down because of too frequent or too extensive overload on the UPS output.	Reduce the load on the UPS output sockets. Then press the OFF button for 2 seconds and then start the UPS system using the ON button.







The  and  symbols and the error code 49 are shown in the display. A continuous alarm sounds.	The UPS input current entered is too high.	Reduce the load on the UPS output sockets. The UPS is then automatically switched back to normal mode.
Error code 14 and continuous alarm.	Short circuit in UPS output.	Disconnect all the loads from the UPS output sockets and restart the UPS system without loads. If the error continues to occur, please contact ONLINE support, see Chapter 7.5. If the error has been fixed, check the loads.
Autonomy time is shorter than expected.	Battery is not fully charged.	Charge the battery for at least 5 hours. If the error continues to occur, please contact ONLINE support, see Chapter 7.5.
	The battery is worn through age or faulty.	Replace the battery, see Chapter 6.4.
Error code 2A and continuous alarm.	Short circuit on charger output	Check the external battery packs for wiring errors, it may be necessary to replace the batteries if they are too old.
The  and  symbols flash and an alarm is sounded every 2 seconds.	The fan is blocked or not working properly. The temperature is too high.	Check the fan is working and there is enough space behind the fan.

Table 13: Troubleshooting

7.4 Muting the alarm

In battery mode, hold the  /  button for at least 2 seconds to mute the alarm. Once the alarm is successfully muted,  appears in the display. Check the status the warning message has triggered and take appropriate measures to rectify the situation. If the status of the warning message changes, the alarm is emitted again. This has priority over the previous muting of the alarm.



PLEASE NOTE

The alarm cannot be muted for alarm and error messages.

7.5 Support

As a German manufacturer, ONLINE guarantees direct approachability, simple processing and short response times. Comprehensive support is a matter of course - before and after purchase.

ONLINE sets great store by comprehensive support and service.

- Free direct advice and support on:
 - Software hotline: +49 (89) 242 39 90 - 13
 - Hardware hotline: +49 (89) 242 39 90 - 18
- Free 24 h advance exchange
- Interactive UPS configurator online or as app
- 2 years full warranty, optional renewal
- Unbureaucratic 14 day money-back guarantee
- Excellent product availability and wide network of distributors.

Further information: www.online-usv.de

8. Technical data

8.1 List of device types

UPS system	Form factor	UPS item no.	Service	Battery pack	Battery pack item no.
XANTO 6000	Rack tower	X6000	6000VA/ 6000W*	Battery pack XANTO 6000	X6000BP
XANTO 10000	Rack tower	X10000	10000VA/ 10000W*	XANTO 10000 battery pack	X10000BP
XANTO 10000 3/1~	Tower	X1000031	10000VA/ 9000W	XANTO battery pack 10000 3/1	X1000031BP
XANTO 20000 3/1~	Tower	X2000031	20000VA/ 18000W		

* Power factor pf = 0.8 if using more than 1 battery pack

Table 14: Overview of UPS systems and battery packs

8.2 Dimensions and weight

UPS system	Dimensions (W x H x D)	Weight
XANTO 6000	438 x 88 (2U) x 610	17kg
XANTO 10000	438 x 88 (2U) x 610	20 kg
XANTO 10000 3/1~	250 x 576 x 592	105kg
XANTO 20000 3/1~	250 x 576 x 592	50kg
XANTO 6000 battery pack	438 x 88 (2U) x 737	47kg
XANTO 10000 battery pack	438 x 88 (2U) x 737	53kg
XANTO 10000 3/1 battery pack	250 x 576 x 592	125kg

Table 15: Dimensions and weight

8.3 Electrical connections

UPS system	Input connection	Output connections
XANTO 6000	Terminal connection	Terminal connection
XANTO 10000	Terminal connection	Terminal connection
XANTO 10000 3/1~	Terminal connection	Terminal connection 2x IEC320 C13 (10A)
XANTO 20000 3/1~	Terminal connection	Terminal connection

Table 16: Electrical connections

8.4 Electrical specifications

Model	XANTO 6000	XANTO 10000	XANTO 10000 3/1~	XANTO 20000 3/1~
Electrical characteristics				
Rated power (VA / W)	6000 / 6000	10000 / 10000	10000 / 9000	20000 / 18000
Technology	Double conversion technology, classification as per VFI-SS-111			
Rated input voltage	230V, 50 / 60Hz		400V, 50 / 60Hz	
Input voltage and input frequency tolerance (without battery in- serted)	110 - 300V (50% load) 176 - 300V (100% load) 46 - 64Hz		110 - 300V (L-N) (50% load) 176 - 276V (L-N) (100% load) 46 - 64Hz	
Output voltage and frequency	230V +/-1.0% (battery mode) (Adjustable to 208 / 220 / 230 / 240V) 50 / 60Hz +/-0.1Hz (battery mode)			
Max. output current	41A	68A	68A	136A
Switchover time	0			
Wave form	Sinewave			
Efficiency, Normal operation	94%		92%	
High-efficiency mode	98%		97%	
Battery mode	91%		87%	88%
Overload-compatible, normal mode				
<110%	Alarm, Bypass/Standby after 10 minutes			
120 – 130%	Alarm, Bypass/Standby after 1 minutes			
>130%	Alarm, Bypass/Standby after 1s			
Battery mode				
<110%	Alarm, Bypass/Standby after 1s			
110 – 130%	Alarm, Bypass/Standby after 10s			
>130%	Alarm, Bypass/Standby after 1s			
Batteries				
Autonomy times	See Table 19: Autonomy times (in minutes) at 50 / 100% load, pf=0.7			
Battery type	See Table 18: Batteries			
Design	Sealed, maintenance-free, valve-controlled, lead/acid, life expectancy 3 to 5 years in accordance with EUROBAT			
Load voltage	218.4V		273V	
Charging current	1A		1A	2A
Communication				
USB	Yes			
RS-232	Yes			
Interface for parallel mode	Yes			

SNMP slot	Yes		
EPO	Yes		
Operating conditions, standards and approvals			
Operating temperature	0 - 40°C		
Rel. air humidity	20 – 90%	0 – 95%	
Operating altitude	<1000m		
Noise level, max.	<55dB	<58dB	<69dB
MTBF at 25°C (w/o battery)	>47.000 hours		>45.000 hours
Safety	EN62040-1		
EMC, Performance	EN62040-2		
Approval	CE		

Table 17: Electrical specifications

8.5 Batteries and autonomy time

UPS system	UPS internal battery	Battery pack
XANTO 6000	-	192V (16x 12V / 7Ah)
XANTO 10000	-	192V (16x 12V / 9Ah)
XANTO 10000 3/1	240V (20x 12V / 9Ah)	240V
XANTO 20000 3/1	-	(2x 20x 12V / 9Ah)

Table 18: Batteries

UPS system	Internal battery	+1BP	+2BP	+3BP	+4BP	+5BP
XANTO 6000	-	17 / 6	46 / 18	72 / 30	106 / 47	139 / 58
XANTO 10000	-	12 / 4	29 / 12	52 / 21	71 / 30	90 / 44
XANTO 10000 3/1	15 / 5	63 / 26	119 / 53	159 / 77	186 / 104	-
XANTO 20000 3/1	-	14 / 5	39 / 15	60 / 27	85 / 42	-

Table 19: Autonomy times (in minutes) at 50 / 100% load, pf=0.7

8.6 Rear view

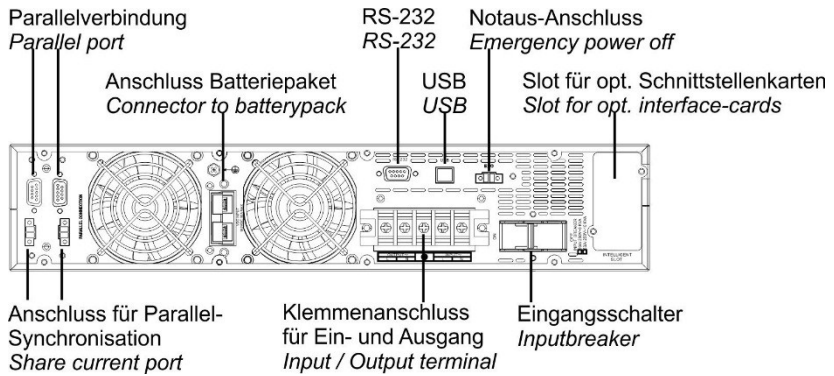

Figure 27: Rear view of XANTO 6000 and 10000

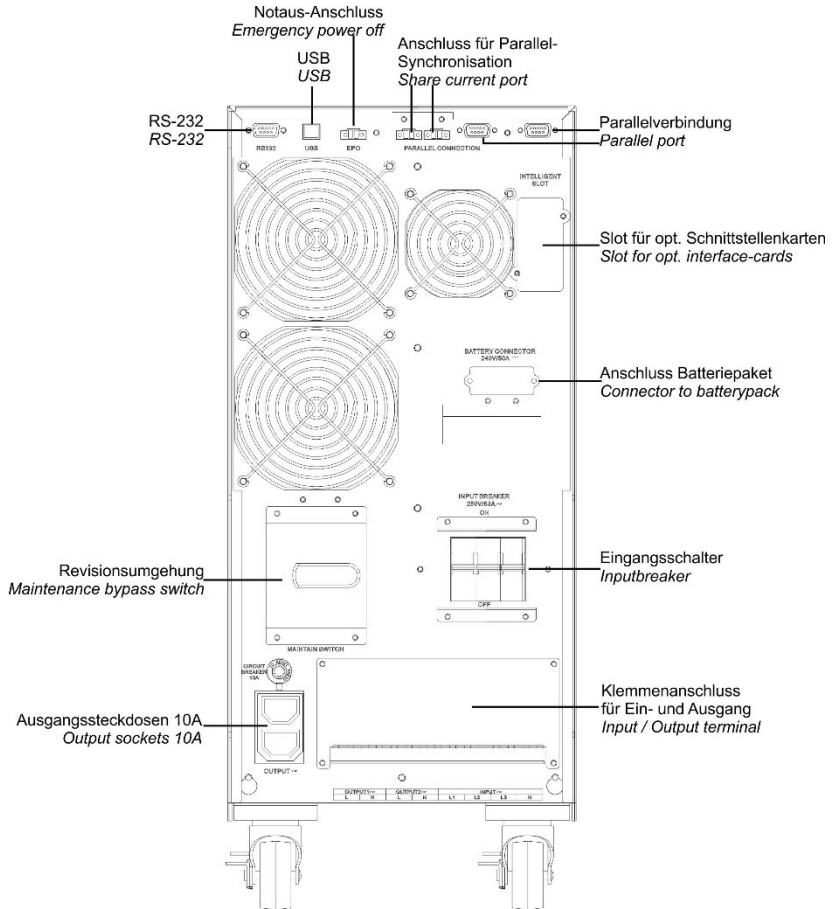

Figure 28: Rear view of XANTO 10000 3/1

TECHNICAL DATA

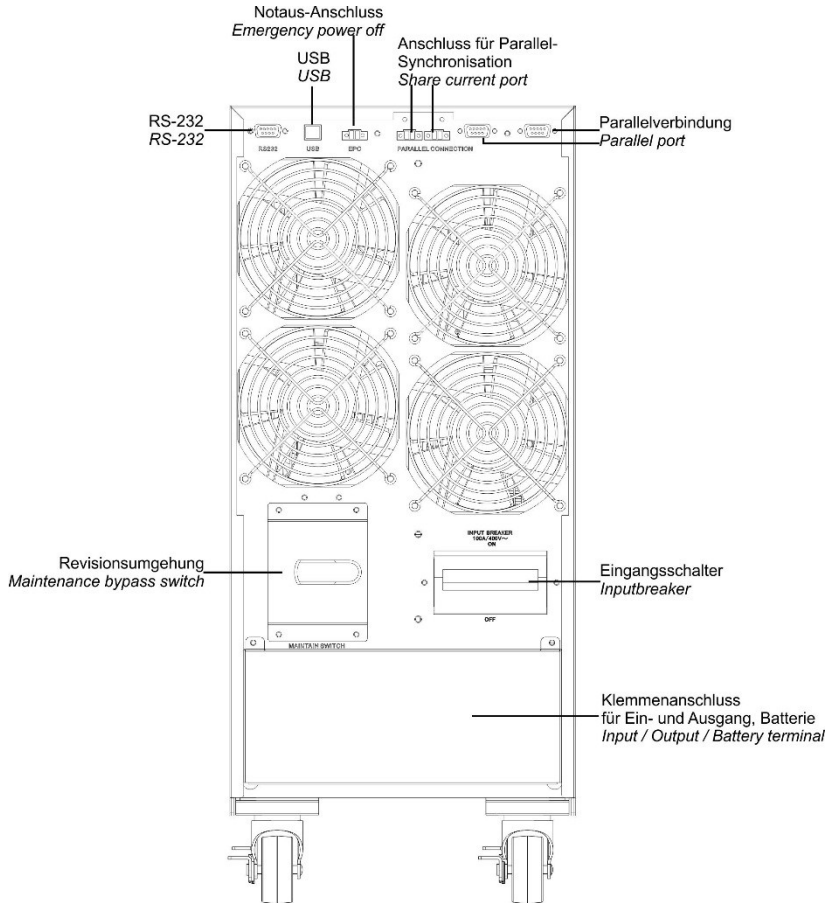

Figure 29: Rear view of XANTO 20000 3/1

8.7 CE confirmation



Online
 USV-Systeme AG
 Luise-Ullrich-Str. 8
 D-82031 Grünwald/Germany
 Telefon +49(0)89/2423990-10
 Telefax +49(0)89/2423990-20

DECLARATION of CONFORMITY

ONLINETM
 U S V · S Y S T E M E A G

Herewith we confirm,
 ONLINE USV-Systeme AG, Luise-Ullrich-Str. 8, 82031 Grünwald / Germany,
 that

Product:	Uninterruptible Power Supply	
Typ:	XANTO 700 (Art.-Nr. X700) XANTO 1000 (Art.-Nr. X1000) XANTO 1500 (Art.-Nr. X1500) XANTO 2000 (Art.-Nr. X2000) XANTO 3000 (Art.-Nr. X3000) XANTO 6000 (Art.-Nr. X6000), XANTO 10000 (Art.-Nr. X10000), XANTO 10000 3/1 (Art.-Nr. X1000031), XANTO 20000 3/1 (Art.-Nr. X2000031)	XANTO 700R (Art.-Nr. X700R), XANTO 1000R (Art.-Nr. X1000R), XANTO 1500R (Art.-Nr. X1500R), XANTO 2000R (Art.-Nr. X2000R), XANTO 3000R (Art.-Nr. X3000R),
and		
Product:	Battery Pack for Uninterruptible Power Supply	
Typ:	Battery Pack XANTO 1000 (Art.-Nr. X1000BP) Battery Pack XANTO 2000 (Art.-Nr. X2000BP), Battery Pack XANTO 3000 (Art.-Nr. X3000BP) Battery Pack XANTO 1000R (Art.-Nr. X1000RBP), Battery Pack XANTO 2000R (Art.-Nr. X2000RBP), Battery Pack XANTO 3000R (Art.-Nr. X3000RBP), Battery Pack XANTO 6000 (Art.-Nr. X6000BP), Battery Pack XANTO 10000 (Art.-Nr. X10000BP), Battery Pack XANTO 10000 3/1 (Art.-Nr. X1000031BP)	

corresponds to the provisions of following directives:

- Low Voltage Directive 2014 / 35 / EU
- EMC Directive 2014 / 30 / EU

For the evaluation of the compliance with these directives, the following standards were applied:

- Low Voltage Directive: EN62040-1: 2008 + A1: 2013
 - EMC Directives: EN62040-2: 2008 + AC: 2006
- EN61000-3-2: 2014 (EN61000-4-4: 2009, EN61000-4-3: 2006, + A2: 2010, EN61000-4-4: 2012, EN61000-4-5: 2006, EN61000-4-6: 2014, EN61000-4-8: 2010, EN61000-2-2: 2009)

Bankverbindung:
 VR-Bank
 Landsberg-Ammersee eG
 Z 700 916 00
 Kto.-Nr. 5 267 110

BIC: GENODEF10SS
 IBAN: DE09 7009 1600
 0005 267110

Name: Sven O. Spitzley
 Position / Titel: Vorstand, Dipl.-Ing. (FH)

Vorstand:
 Hans Setzle (Vorsitzender)
 Sven Spitzley
 Aufsichtsratsvorsitzender:
 André Kollmaß

Grünwald, 14. March 2017

Amtsgericht München
 HRB 138051

\\X700-20000*BP_CE-Declaration_20170314.doc

Ust-Id-Nr./VAT Reg.No.
 DE 128672915

9. Warranty

ONLINE USV-Systeme AG (ONLINE) guarantees that this product will be free of material and production faults for a period of two years from the purchase date. ONLINE's obligation in accordance with this guarantee is restricted to the repair or replacement (at ONLINE's discretion) of any faulty products. Before warranty claims can be asserted, a Returned Material Authorization (RMA) number must be obtained from customer services. Products must be returned with the postage paid by the sender, a brief description of the problem and evidence of the place and date of purchase. This warranty does not apply to devices damaged by accidents, negligence or misuse or those which have otherwise been altered or modified.

Apart from the above exceptions, ONLINE accepts no explicit or tacit warranty, including a guarantee of conventional quality or suitability for a specific purpose. In some jurisdictions, the restriction or exclusion of tacit guarantees is prohibited, which means that the restrictions or exclusions above may not apply to the purchaser.

Irrespective of the above exclusions, ONLINE shall under no circumstances for direct, indirect, specific, auxiliary or subsequent damage caused as a result of the use of this product, even if ONLINE was informed about the possibility of such damage. In particular, ONLINE shall not be liable for costs of whatsoever nature, such as lost profit or revenue, loss of equipment, loss of the use of device, loss of software or data, replacement costs, third-party claims or other costs.

The content is copyright © 2017 by ONLINE USV-Systeme AG. All rights reserved. Unauthorised reproduction in part or in whole is not permitted without consent.